



# JP ENTERPRISES

Product:  
JPGS-5

## ADJUSTABLE GAS SYSTEM

.750 bore minimized stainless steel

### PARTS INCLUDED

- .750 bore gas block
- Four (4) 6-32 x 1/2" socket head cap screws
- One (1) 6-32 x 3/8" gas adjustment set screw
- One (1) 6-32 x 1/4" locking set screw
- 1/16 hex key
- T15 Torx key
- 5/64" x 1/2" roll pin (for gas tube)
- 3/32" x 5/8" roll pin (for optional pinning)

### CAUTION:

**REMOVE THE MAGAZINE AND VISUALLY CHECK THE CHAMBER TO ENSURE THAT YOUR FIREARM IS UNLOADED.**

This small-bore JP Adjustable Gas System is designed for use on barrels with a .750 gas block journal and should fit with little or no modification needed. We strongly encourage you to read through these instructions once before beginning the installation process. This installation will require the use of Loctite® 243 or an equivalent thread locker, which is not included in the package.

The minimized JPGS-5 series gas block is designed to fit under most models of free-floating hand guards. Keep in mind that while this gas block will function easily with JP MK III Hand Guards, the accessibility of the adjustment screw will vary with other brands.

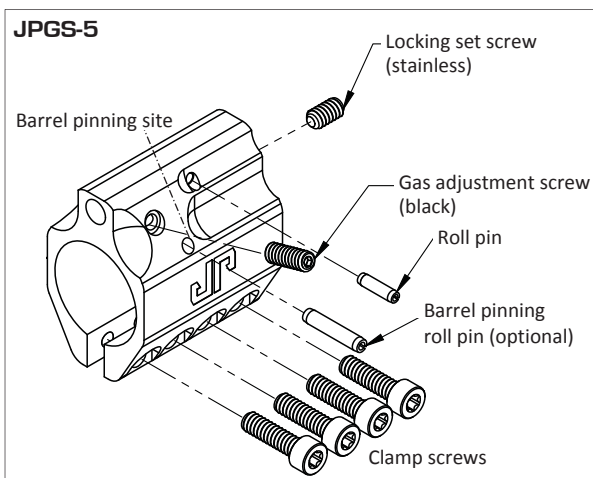

## BARREL PREPARATION

1. If you are installing this device on a barrel that is already in assembly in your upper, first remove the takedown pins and separate the lower and upper assemblies to make the job easier.
2. Secure the upper assembly in an appropriate vise. We recommend using our soft-anodized JP Vise Clamps or padded vise jaws.
3. If you already have a gas block installed, you will need to uninstall it along with any other accessories that will cover or block the gas block such as the hand guard and muzzle treatment, depending on your situation. If you intend to reuse the original gas tube, remove the roll pin securing it in the existing gas block using a 1/16" drift.
4. If you've removed an old gas block or front sight, inspect your gas block journal for any high spots or burrs. File any high spots to ensure tight seal on the gas block.

## INSTALLATION

1. Making sure that the **gas adjustment screw** is not installed in the gas block, insert the gas tube and secure it using the gas tube **roll pin** supplied. One side of the gas block has a pin hole enlarged to facilitate starting the pin. It may be necessary to run a 6-32 bottoming tap into the screw hole before installing the adjustment set screw due to it abutting the bottom of the gas tube.
2. Clean the 6-32 x 3/8" **gas adjustment screw** with lacquer thinner or an appropriate solvent. Thread the screw in until it bottoms out, and then turn it back one full turn.
3. Install the stainless 6-32 x 1/4" **locking set screw** into the hole from the front of the gas block. This screw will be used at the end of the setup phase. Do not tension this screw all the way down against the **gas adjustment screw** at this time.
4. With the gas tube installed, slide the tube through the gas tube hole in the upper receiver until the gas block butts up against the shoulder behind the gas port collar of the barrel. Take care not to scratch the barrel.

If you find the gas block to be very tight around the barrel, one trick is to insert one of the 6-32 **clamp screws** into one of the center positions and slightly tension it against a shim such as a quarter or a disconnecter placed in the slot. This will spread the gas block to allow more clearance. Spread the block as little as necessary to avoid damaging it.

5. Align the gas block to the barrel. If you are using a JP Supermatch™ or similar barrel, ensure that the gas block is seated against the shoulder of the gas block journal.

If your barrel is designed for a Mil-spec gas block and hand guard spacer, you will need to move the gas block forward approximately .025" from the shoulder to account for the hand guard retainer. Otherwise, you will need to measure the distance from the gas block shoulder to the center of the gas port to ensure proper alignment to the gas block.

6. Use a level to align the top of the gas block to the upper receiver rail. This will ensure the gas ports in the gas block and the barrel are aligned radially.

At this point, you can test the gas block with compressed air to ensure proper alignment. With the bolt inserted and closed, push the air nozzle up to the muzzle and apply air while moving the gas block around until you hear maximum flow.

9. Install the socket head **clamp screws** to retain the gas block's position. **Install the clamp screws only from the direction shown.** Initially, install the screws only finger tight. Then, go back and tighten each bit by bit to approximately 18-20 inch-pounds of torque. As an option for added stability, you can apply a thread locker like Loctite® 609 between the barrel and gas block to more permanently secure them. If you use thread locker, make sure the surfaces have been cleaned with solvent. **Before use, allow all thread locker to set up according to the product instructions.**

#### PINNING THE GAS BLOCK

For added stability and reduced potential for migration under heavy use, this model of JP gas block is designed to facilitate pinning to the barrel, though be aware that this involves permanent modification to the gas block and the barrel. While this process can be performed with a hand drill, a drill press is better suited to the task.

With the gas block mounted as described in these instructions, locate the pilot hole indicated in the diagram and use a 3/32" to drill all the way through the gas block and barrel, and out the other side. Then, with a hammer and suitable punch, drive in a 3/32" x 5/8" roll or spring pin so that it does not protrude past the exterior wall of the gas block on either side. Due to the QPQ coating on the black version of the GS-5, you'll want to use a carbide drill bit to avoid excessive wear.

#### GAS BLOCK SETUP

Most rifles cycle faster than is necessary, and the resulting "bolt slamming" effect is a noticeable part of the recoil impulse. The main purpose of our adjustable gas blocks is to allow adjustment of port pressure to the operating system, thereby fine-tuning the bolt velocity, which will result in a smoother shooting rifle, especially if you already have a JP Recoil Eliminator or JP Compensator. Additionally, the JP Adjustable Gas System is useful in obtaining optimum port pressure on otherwise difficult to run setups such as suppressed weapons, short-barreled weapons, or nonstandard cartridges. These steps will walk you through setting your gas block for the particular load you'll be using.

1. Begin by turning the **gas adjustment screw** in all the way to close off the valve. The symptoms of too much gas and too little gas can actually appear similar enough to be mistaken for each other at times. So, to determine the optimum gas setting, you'll want to start out at a setting that is definitely too low and work up from there.
2. Back the **gas adjustment screw** out  $\frac{1}{2}$  a turn. Load a single round into the magazine, chamber it, and fire. If the bolt doesn't open at all, open it another  $\frac{1}{2}$  turn and try again. Most likely, the bolt will short stroke at this setting. Assuming that is the case, clear the rifle before proceeding.
3. Back the **gas adjustment screw** out by another  $\frac{1}{4}$  turn and fire again. Repeat this sequence until the carrier locks open after the round has been fired. Verify this setting with a few more rounds. If the bolt consistently locks back, you've effectively found the optimum gas setting, though you may want to open the valve another  $\frac{1}{4}$  to  $\frac{1}{2}$  turn for reliability, especially if you expect to shoot different or unknown loads.
4. Tighten the **locking set screw** down against the **gas adjustment screw** to 8-10 inch-pounds. Tension provided by this screw will securely retain the adjustment screw and prevent migration. However, it should not be used as a tensioning screw, so make sure to loosen it before changing the setting of the **gas adjustment screw** of the gas block.

Though most likely unnecessary, you can also apply a small drop of Loctite® 243 to the **gas adjustment screw**, but do not add Loctite® to the **locking set screw**.

Keep in mind that the gas block has been set for the specific ammo you've tested it with and still may not cycle reliably or optimally with other loads due to their different pressures. Make sure to test the valve setting with any ammunition you intend to use in competition. If your rifle is used for law enforcement or military purposes, we recommend running your rifle with the gas valve fully open so as not to compromise reliability.

Also, be aware that new bolt assemblies and carriers will have more friction in their relationship than parts that have worn in. These may require a break-in period when the gas block valve will have to be set further open until the friction between the parts is reduced. It helps to polish the bore of the carrier on a new bolt to reduce friction and mate the parts.

**THANKS FOR YOUR BUSINESS!**